



AHM36I-S3QC014x12

AHS/AHM36

ABSOLUTE ENCODERS

SICK
Sensor Intelligence.



Illustration may differ



Ordering information

| Type | Part no. |
|-------------------|----------|
| AHM36I-S3QC014x12 | 1092667 |

Other models and accessories → www.sick.com/AHS_AHM36

Detailed technical data

Performance

| | |
|---|----------------------------------|
| Max. resolution (number of steps per revolution x number of revolutions) | 14 bit x 12 bit (16,384 x 4,096) |
| Error limits G | 0.35° (at 20 °C) ¹⁾ |
| Repeatability standard deviation σ_r | 0.2° (at 20 °C) ²⁾ |

¹⁾ In accordance with DIN ISO 1319-1, position of the upper and lower error limit depends on the installation situation, specified value refers to a symmetrical position, i.e. deviation in upper and lower direction is the same.

²⁾ In accordance with DIN ISO 55350-13; 68.3% of the measured values are inside the specified area.

Interfaces

| | |
|---------------------------------------|--|
| Communication interface | IO-Link |
| Communication Interface detail | V1.1 / COM3 (230,4 kBaud) |
| Smart Sensor | Efficient communication, Enhanced Sensing |
| Process data | Position, speed |
| Parameterising data | Number of steps per revolution Number of revolutions PRESET Counting direction Sampling rate for speed calculation Unit for output of the speed value |
| Status information | Via status LED |
| Initialization time | 2 s |
| Cycle time | ≤ 3.2 ms |

Electrical data

| | |
|--|---------------------------------------|
| Connection type | Male connector, M12, 4-pin, universal |
| Supply voltage | 18 ... 30 V |
| | Male connector, M12, 4-pin |
| Power consumption | ≤ 1.5 W |
| Reverse polarity protection | ✓ |
| MTTFd: mean time to dangerous failure | 145.6 years (EN ISO 13849-1) |

Mechanical data

| | |
|---|---|
| Mechanical design | Solid shaft, face mount flange |
| Shaft diameter | 6 mm |
| Shaft length | 12 mm |
| Weight | 0.2 kg, relates to devices with male connector connection |
| Shaft material | Stainless steel V2A |
| Flange material | Stainless steel V2A |
| Material, stator coupling | Stainless steel V2A |
| Housing material | Stainless steel V2A |
| Material, cable | PUR |
| Start up torque | $\leq 1 \text{ Ncm}^1$ |
| Operating torque | $\leq 1 \text{ Ncm}^1$ |
| Permissible Load capacity of shaft | 40 N / radial 20 N / axial |
| Moment of inertia of the rotor | 2.5 gcm ² |
| Bearing lifetime | 3.6 x 10 ⁸ revolutions |
| Angular acceleration | $\leq 500,000 \text{ rad/s}^2$ |
| Operating speed | $\leq 6,000 \text{ min}^{-1}$ |

¹⁾ At 20 °C.

Ambient data

| | |
|--------------------------------------|--|
| EMC | According to EN 61000-6-2, EN 61000-6-3 and EN 61131-9 |
| Enclosure rating | IP67 (IEC 60529) IP69K (IEC 60529) |
| Permissible relative humidity | 90 % (Condensation not permitted) |
| Operating temperature range | -40 °C ... +85 °C |
| Storage temperature range | -40 °C ... +100 °C |
| Resistance to shocks | 100 g, 6 ms (according to EN 60068-2-27) |
| Resistance to vibration | 20 g, 10 Hz ... 2,000 Hz (according to EN 60068-2-6) |

Classifications

| | |
|---------------------|----------|
| ECl@ss 5.0 | 27270502 |
| ECl@ss 5.1.4 | 27270502 |
| ECl@ss 6.0 | 27270590 |
| ECl@ss 6.2 | 27270590 |
| ECl@ss 7.0 | 27270502 |
| ECl@ss 8.0 | 27270502 |
| ECl@ss 8.1 | 27270502 |
| ECl@ss 9.0 | 27270502 |
| ECl@ss 10.0 | 27270502 |
| ECl@ss 11.0 | 27270502 |
| ETIM 5.0 | EC001486 |
| ETIM 6.0 | EC001486 |

| | |
|-----------------------|----------|
| ETIM 7.0 | EC001486 |
| UNSPSC 16.0901 | 41112113 |

Dimensional drawing (Dimensions in mm (inch))

Solid shaft, face mount flange, connector outlet

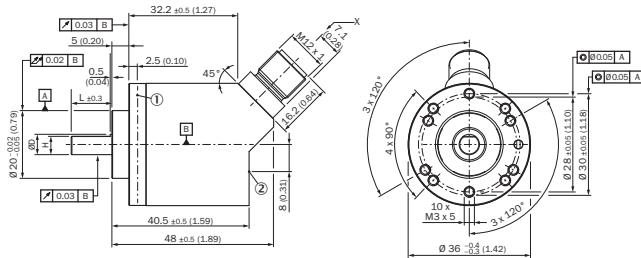

Non-tolerated dimensions according to DIN-ISO 2768-mk

- ① Measuring point for operating temperature
- ② Measuring point for vibrations

Attachment specifications

Solid shaft, face mount flange with flange adapter, centering collar D20 on D50 (BEF-FA-020-050-I, 2103985)

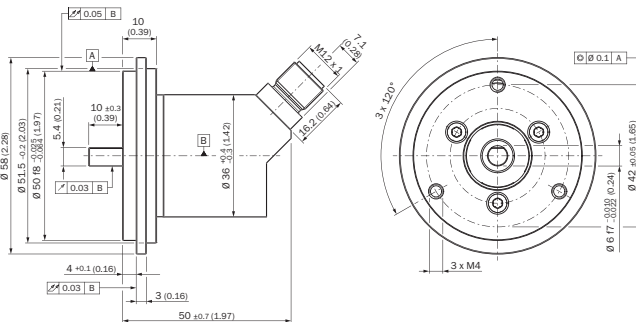

Order example for 6 mm shaft diameter: AHx36I-S3xx0xxxx + BEF-FA-020-050-I (adapter is not pre-assembled)

Solid shaft, face mount flange with flange adapter, centering collar D20 on D24 (BEF-FA-020-024-I, 2103982)

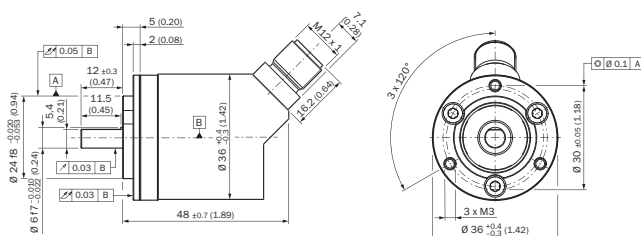

Order example for 6 mm shaft diameter: AHx36I-S3xx0xxxx + BEF-FA-020-024-I (adapter is not pre-assembled)

Solid shaft, face mount flange with flange adapter, centering collar D20 on D36, 2 mm high (BEF-FA-020-036-2-I, 2103984)

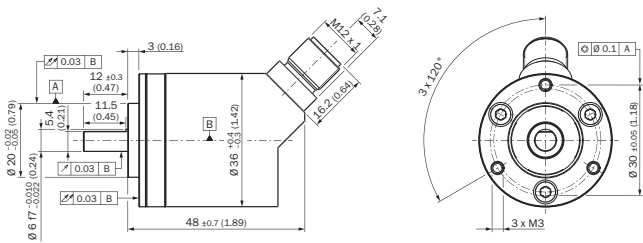

Order example for 6 mm shaft diameter: AHx36I-S3xx0xxxxx + BEF-FA-020-036-2-I (adapter is not pre-assembled)

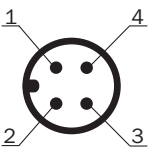

PIN assignment



| PIN | Wire color | Signal | Function | | |
|-----|------------|--------|--------------------------------------|--|----------------------------------|
| | | | Basic | Advanced | Advanced Smart Task |
| 1 | Brown | L+ | Encoder supply voltage 18-30 V (+Us) | | |
| 2 | White | I/Q | Not connect- ed - no function | Multifunctional pin (configurable as switching input or switching output) | |
| 3 | Blue | L- | Encoder supply voltage 0 V (GND) | | |
| 4 | Black | C/Q | IO-Link communication | | Switching out- put (SIO mode) |



Recommended accessories

Other models and accessories → www.sick.com/AHS_AHM36

| | Brief description | Type | Part no. |
|---|---|------------|----------|
| Shaft adaptation | | | |
|  | Bellows coupling, shaft diameter 6 mm / 6 mm, maximum shaft offset: radial ± 0.25 mm, axial ± 0.4 mm, angular +/- 4°; max. speed 10,000 rpm, -30 °C to +120 °C, max. torque 80 Ncm; material: stainless steel bellows, aluminum hub | KUP-0606-B | 5312981 |
| | Bellows coupling, shaft diameter 6 mm / 10 mm, maximum shaft offset: radial ± 0.25 mm, axial ± 0.4 mm, angular +/- 4°; max. speed 10,000 rpm, -30 °C to +120 °C, max. torque 80 Ncm; material: stainless steel bellows, aluminum hub | KUP-0610-B | 5312982 |
|  | Double loop coupling, shaft diameter 6 mm / 10 mm, max. shaft offset: radially +/- 2,5 mm, axially +/- 3 mm, angle +/- 10 degrees; max. speed 3.000 rpm, -30 to +80 degrees Celsius, torsional spring stiffness of 25 Nm/rad | KUP-0610-D | 5326697 |
|  | Spring washer coupling, shaft diameter 6 mm / 10 mm, Maximum shaft offset: radial +/- 0.3 mm, axial +/- 0.4 mm, angular +/- 2.5°; max. speed 12,000 rpm, -10° to +80 °C, max. torque 60 Ncm; material: aluminum flange, glass fiber-reinforced polyamide membrane and hardened steel coupling pin | KUP-0610-F | 5312985 |

| | Brief description | Type | Part no. |
|---|--|-----------------|----------|
| Plug connectors and cables | | | |
|  | Head A: female connector, M12, 4-pin, straight Head B: Flying leads Cable: PVC, unshielded, 2 m This product is generally resistant to chemical cleaning agents (see ECOLAB). Please do not use cleaning agents of any other Kind., Not resistant against lactic acid & hydrogen peroxide (H2O2) | DOL-1204-G02MNI | 6052613 |
|  | Head A: female connector, M12, 4-pin, straight Head B: Flying leads Cable: PP, unshielded, 2 m This product is generally resistant to chemical cleaning agents (see ECOLAB) and other chemical compounds such as H2O2 and CH2O2. Before permanent installation is carried out, the material's resistance to the cleaning agent being used must be checked., Resistant against lactic acid & hydrogen peroxide (H2O2) | DOL-1204-G02MRN | 6058291 |
|  | Head A: female connector, M12, 4-pin, straight Head B: Flying leads Cable: PVC, unshielded, 5 m This product is generally resistant to chemical cleaning agents (see ECOLAB). Please do not use cleaning agents of any other Kind., Not resistant against lactic acid & hydrogen peroxide (H2O2) | DOL-1204-G05MNI | 6052615 |
|  | Head A: female connector, M12, 4-pin, straight Head B: Flying leads Cable: PP, unshielded, 5 m This product is generally resistant to chemical cleaning agents (see ECOLAB) and other chemical compounds such as H2O2 and CH2O2. Before permanent installation is carried out, the material's resistance to the cleaning agent being used must be checked., Resistant against lactic acid & hydrogen peroxide (H2O2) | DOL-1204-G05MRN | 6058476 |
|  | Head A: female connector, M12, 4-pin, straight Head B: Flying leads Cable: PVC, unshielded, 10 m This product is generally resistant to chemical cleaning agents (see ECOLAB). Please do not use cleaning agents of any other Kind., Not resistant against lactic acid & hydrogen peroxide (H2O2) | DOL-1204-G10MNI | 6052617 |
|  | Head A: female connector, M12, 4-pin, straight Head B: Flying leads Cable: PP, unshielded, 10 m This product is generally resistant to chemical cleaning agents (see ECOLAB) and other chemical compounds such as H2O2 and CH2O2. Before permanent installation is carried out, the material's resistance to the cleaning agent being used must be checked., Resistant against lactic acid & hydrogen peroxide (H2O2) | DOL-1204-G10MRN | 6058478 |
|  | Head A: female connector, M12, 4-pin, angled Head B: Flying leads Cable: PVC, unshielded, 2 m This product is generally resistant to chemical cleaning agents (see ECOLAB). Please do not use cleaning agents of any other Kind., Not resistant against lactic acid & hydrogen peroxide (H2O2) | DOL-1204-W02MNI | 6052614 |
|  | Head A: female connector, M12, 4-pin, angled Head B: Flying leads Cable: PP, unshielded, 2 m This product is generally resistant to chemical cleaning agents (see ECOLAB) and other chemical compounds such as H2O2 and CH2O2. Before permanent installation is carried out, the material's resistance to the cleaning agent being used must be checked., Resistant against lactic acid & hydrogen peroxide (H2O2) | DOL-1204-W02MRN | 6058474 |
|  | Head A: female connector, M12, 4-pin, angled Head B: Flying leads Cable: PVC, unshielded, 5 m This product is generally resistant to chemical cleaning agents (see ECOLAB). Please do not use cleaning agents of any other Kind., Not resistant against lactic acid & hydrogen peroxide (H2O2) | DOL-1204-W05MNI | 6052616 |

| | Brief description | Type | Part no. |
|---|---|-----------------|----------|
|  | Head A: female connector, M12, 4-pin, angled Head B: Flying leads Cable: PP, unshielded, 5 m This product is generally resistant to chemical cleaning agents (see ECOLAB) and other chemical compounds such as H2O2 and CH2O2. Before permanent installation is carried out, the material's resistance to the cleaning agent being used must be checked., Resistant against lactic acid & hydrogen peroxide (H2O2) | DOL-1204-W05MRN | 6058477 |
|  | Head A: female connector, M12, 4-pin, angled Head B: Flying leads Cable: PVC, unshielded, 10 m This product is generally resistant to chemical cleaning agents (see ECOLAB). Please do not use cleaning agents of any other Kind., Not resistant against lactic acid & hydrogen peroxide (H2O2) | DOL-1204-W10MNI | 6052618 |
|  | Head A: female connector, M12, 4-pin, angled Head B: Flying leads Cable: PP, unshielded, 10 m This product is generally resistant to chemical cleaning agents (see ECOLAB) and other chemical compounds such as H2O2 and CH2O2. Before permanent installation is carried out, the material's resistance to the cleaning agent being used must be checked., Resistant against lactic acid & hydrogen peroxide (H2O2) | DOL-1204-W10MRN | 6058479 |
|  | Head A: female connector, M12, 4-pin, angled Head B: male connector, M12, 4-pin, straight Cable: PVC, unshielded, 2 m This product is generally resistant to chemical cleaning agents (see ECOLAB). Please do not use cleaning agents of any other Kind., Not resistant against lactic acid & hydrogen peroxide (H2O2) | DSL-1204-B02MNI | 6052633 |
|  | Head A: female connector, M12, 4-pin, angled Head B: male connector, M12, 4-pin, straight Cable: PP, unshielded, 2 m This product is generally resistant to chemical cleaning agents (see ECOLAB) and other chemical compounds such as H2O2 and CH2O2. Before permanent installation is carried out, the material's resistance to the cleaning agent being used must be checked., Resistant against lactic acid & hydrogen peroxide (H2O2) | DSL-1204-B02MRN | 6058502 |
|  | Head A: female connector, M12, 4-pin, angled Head B: male connector, M12, 4-pin, straight Cable: PVC, unshielded, 5 m This product is generally resistant to chemical cleaning agents (see ECOLAB). Please do not use cleaning agents of any other Kind., Not resistant against lactic acid & hydrogen peroxide (H2O2) | DSL-1204-B05MNI | 6052634 |
|  | Head A: female connector, M12, 4-pin, angled Head B: male connector, M12, 4-pin, straight Cable: PP, unshielded, 5 m This product is generally resistant to chemical cleaning agents (see ECOLAB) and other chemical compounds such as H2O2 and CH2O2. Before permanent installation is carried out, the material's resistance to the cleaning agent being used must be checked., Resistant against lactic acid & hydrogen peroxide (H2O2) | DSL-1204-B05MRN | 6058503 |
|  | Head A: female connector, M12, 4-pin, straight Head B: male connector, M12, 4-pin, straight Cable: PVC, unshielded, 2 m This product is generally resistant to chemical cleaning agents (see ECOLAB). Please do not use cleaning agents of any other Kind., Not resistant against lactic acid & hydrogen peroxide (H2O2) | DSL-1204-G02MNI | 6052630 |
|  | Head A: female connector, M12, 4-pin, straight Head B: male connector, M12, 4-pin, straight Cable: PP, unshielded, 2 m This product is generally resistant to chemical cleaning agents (see ECOLAB) and other chemical compounds such as H2O2 and CH2O2. Before permanent installation is carried out, the material's resistance to the cleaning agent being used must be checked., Resistant against lactic acid & hydrogen peroxide (H2O2) | DSL-1204-G02MRN | 6058499 |

| | Brief description | Type | Part no. |
|---|--|-----------------|----------|
|  | <p>Head A: female connector, M12, 4-pin, straight Head B: male connector, M12, 4-pin, straight Cable: PVC, unshielded, 5 m This product is generally resistant to chemical cleaning agents (see ECOLAB). Please do not use cleaning agents of any other Kind., Not resistant against lactic acid & hydrogen peroxide (H2O2)</p> | DSL-1204-G05MNI | 6052631 |
|  | <p>Head A: female connector, M12, 4-pin, straight Head B: male connector, M12, 4-pin, straight Cable: PP, unshielded, 5 m This product is generally resistant to chemical cleaning agents (see ECOLAB) and other chemical compounds such as H2O2 and CH2O2. Before permanent installation is carried out, the material's resistance to the cleaning agent being used must be checked., Resistant against lactic acid & hydrogen peroxide (H2O2)</p> | DSL-1204-G05MRN | 6058500 |

SICK AT A GLANCE

SICK is one of the leading manufacturers of intelligent sensors and sensor solutions for industrial applications. A unique range of products and services creates the perfect basis for controlling processes securely and efficiently, protecting individuals from accidents and preventing damage to the environment.

We have extensive experience in a wide range of industries and understand their processes and requirements. With intelligent sensors, we can deliver exactly what our customers need. In application centers in Europe, Asia and North America, system solutions are tested and optimized in accordance with customer specifications. All this makes us a reliable supplier and development partner.

Comprehensive services complete our offering: SICK LifeTime Services provide support throughout the machine life cycle and ensure safety and productivity.

For us, that is “Sensor Intelligence.”

WORLDWIDE PRESENCE:

Contacts and other locations –www.sick.com